

ELECTRIC MONITORING DEVICES

Model PS-10

Pressure switch



PRODUCT DESCRIPTION

Pressure water flow switches model PS10 has been designed to be installed on a fire sprinkler system. It is suitable for indoor or outdoor service with a NEMA 4/IP66 rating.

TECHNICAL DATA

Models	PS10-1 Pressure switch with one set SPDT contact PS10-2 Pressure switch with two sets SPDT contacts
Conduit entrance	Two knockouts provided for 1/2" conduit. Individual switch compartments and ground screws suitable for dissimilar voltages
Enclosure	Cover: Die-cast with textured red powdercoat finish, single cover screw and rain lip. Base: Die-cast
Pressure connection	Nylon 1/2" NPT Male
Factory adjustment	4 to 8 psi (0,27 to 0,55 bar)
Differential	2 psi (0,13 bar) typical
Maximum system pressure	300 psi (20,68 bar)
Switch contacts	SPDT (Form C) 10,1 Amps at 125/250V AC, 2.0 Amps at 30VDC One SPDT in PS10-1, Two SPDT in PS10-2
Environmental specifications	NEMA 4/IP66 Rated Enclosure – indoor or outdoor when used with NEMA 4 conduit fittings Temperature range: - 40 to 140°F (- 40 to 60°C)
Service use	Automatic Sprinkler NFPA - 13 One or two family dwelling NFPA – 13D Residential Occupancy up to four stories NFPA-13R National Fire Alarm Code NFPA – 72

WIRING INSTRUCTIONS

1. Remove the tamper resistant screw with the special key provided.
2. Carefully place a screwdriver on the edge of the knockout and sharply apply a force sufficient to dislodge the knockout plug.
3. Run wires through an approved conduit connector and affix the connector to the device.
4. Connect the wires to the appropriate Terminal connections for the service intended.

DIMENSIONS

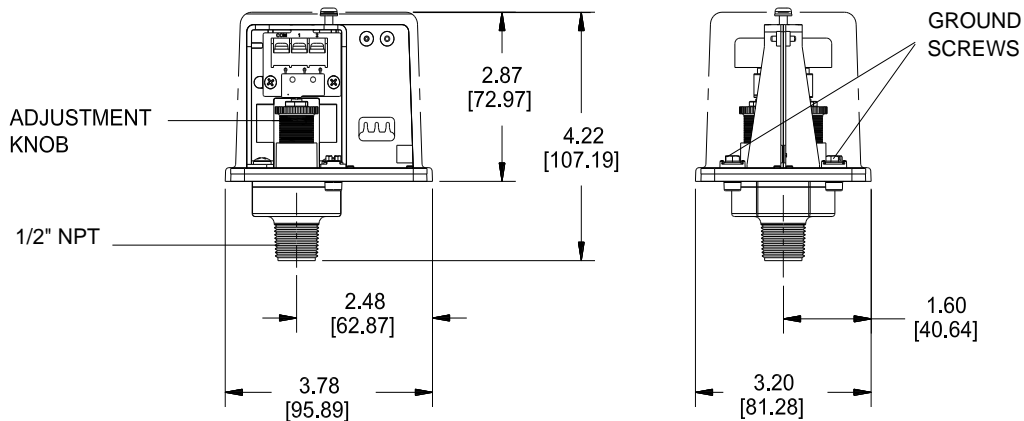

NOTE: To prevent leakage, apply Teflon tape sealant to male threads only.

WET SYSTEM

Method 1: When using PS10 and control unit with retard - connect PS10 into alarm port piping on the input side of retard chamber and electrically connect PS10 to control unit that provides a retard to compensate for surges. Insure that no unsupervised shut-off valves are present between the alarm check valve and PS10.

Method 2: When using the PS10 for local bell application or with a control that does not provide a retard feature the PS10 must be installed on the alarm outlet side of the retard chamber of the sprinkler system.

Testing: Accomplished by opening the inspector's end-of-line test valve. Allow time to compensate for system or control retard. **Note:** Method 2 is not applicable for remote station service use, if there is an unsupervised shut-off valve between the alarm check valve and the PS10.

WET SYSTEM WITH EXCESS PRESSURE

Connect PS10 into alarm port piping extending from alarm check valve. Retard provisions are not required. Insure that no unsupervised shutoff valves are present between the alarm check valve and the PS10.

Testing: Accomplished by opening the water by-pass test valve or the inspector's end-of-line test valve. When using end-of-line test, allow time for excess pressure to bleed off.

DRY SYSTEM

Connect PS10 into alarm port piping that extends from the intermediate chamber of the alarm check valve. Install on the outlet side of the in-line check valve of the alarm port piping. Insure that no unsupervised shut-off valves are present between the alarm check valve and the PS10.

Testing: Accomplished by opening the water bypass test valve.

Note: The above tests may also activate any other circuit closer or water motor gongs that are present on the system.

SWITCH CLAMPING PLATE TERMINAL

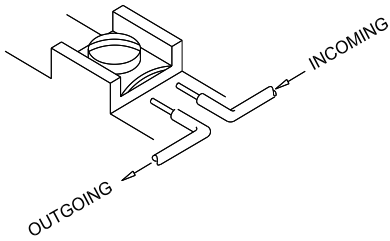

WARNING

An uninsulated section of a single conductor should not be looped around the terminal and serve as two separate connections. The wire must be severed, thereby providing supervision of the connection in the event that the wire becomes dislodged from under the terminal.

TYPICAL SPRINKLER APPLICATIONS

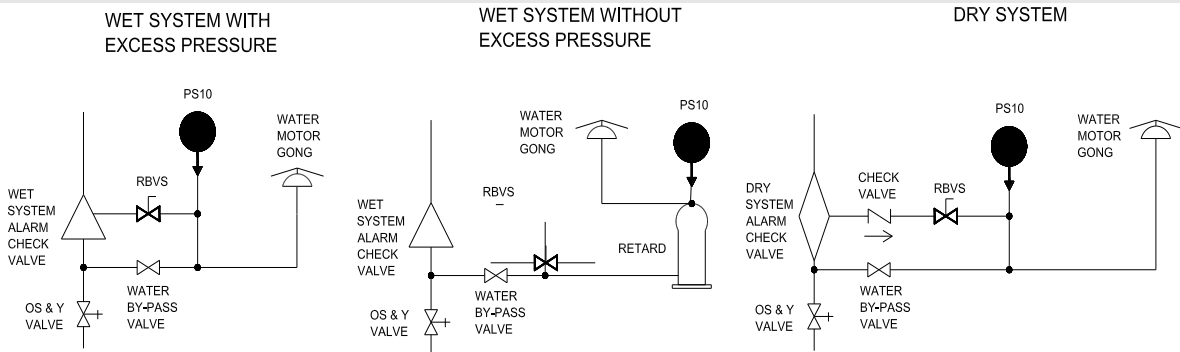

CAUTION

Closing of any shutoff valves between the alarm check valve and the PS10 will render the PS10 inoperative. To comply with NFPA-72 any such valve shall be electrically supervised with a supervisory switch such as model RBVS.

SIGNAL CONNECTION

Low Pressure Signal Connection

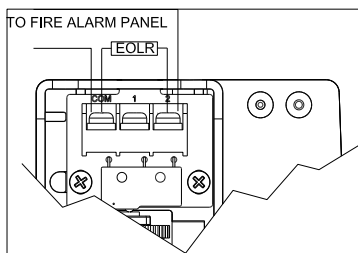

Waterflow signal connection

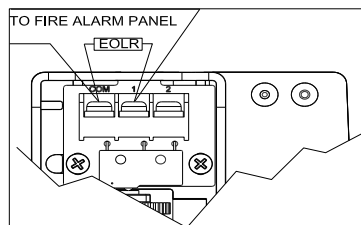

Local Bell For Waterflow connection

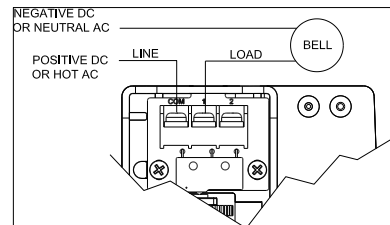

One Conduit Wiring

Break out thin section of divider to provide path for wires when both switches from one conduit entrance.

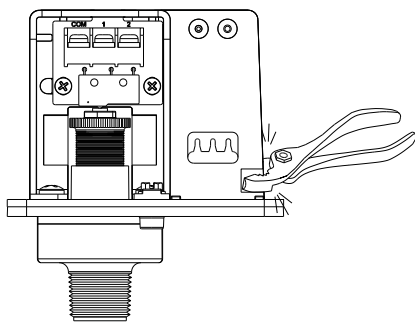

Changing Pressure

Terminal
C: Common
1: Closed when installed under normal system pressure.
2: Open when installed under normal system pressure. Closes upon pressure drop. Use for low pressure supervision.

Terminal
1: Open with no pressure supplied. Closes upon detection of pressure. Use for waterflow indication.
2: Closed with no pressure applied.

W/ PRESSURE APPLIED

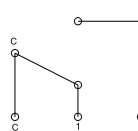

W/O PRESSURE APPLIED

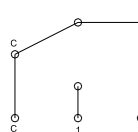

Removing Knockouts

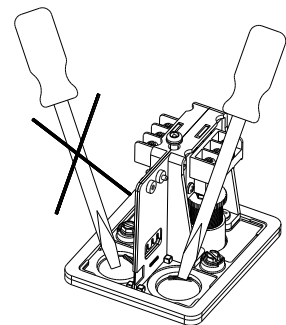

WARNING

Installation must be performed by qualified personnel and in accordance with all national and local codes and ordinances.

Shock hazard. Disconnect power source before servicing. Serious injury or death could result.

Read all instructions carefully and understand them before starting installation. Save instructions for future use. Failure to read and understand instructions could result in improper operation of device resulting in serious injury or death.

Risk of explosion. Not for use in hazardous locations. Serious injury or death could result.

CAUTION

Do not tighten by grasping the switch enclosure. Use wrenching flats on the bushing only. Failure to install properly could damage the switch and cause improper operation resulting in damage to equipment and property.

To seal threads, apply Teflon tape to male threads only. Using joint compounds or cement can obstruct the pressure port inlet and result in improper device operation and damage to equipment.

Do not over tighten the device, standard piping practices apply.

INSTALLATION

The PS10 are designed for the detection of a water flow condition in automatic fire sprinkler systems of particular designs such as wet pipe systems with alarm check valves, dry pipe, preaction, or deluge valves. The PS10 is also suitable to provide a low pressure supervisory signal; adjustable between 4 and 15 psi (0,27 and 1,03 bar).

1. Apply Teflon tape to the threaded male connection on the device. (Do not use pipe dope)
2. Device should be mounted in the upright position (threaded connection down).
3. Tighten the device using a wrench on the flats on the device.

TESTING

The operation of the pressure alarm switch should be tested upon completion of installation and periodically thereafter in accordance with the applicable NFPA codes and standards and/or the authority having jurisdiction (manufacturer recommends quarterly or more frequently).

ORDERING INFORMATION

MODEL	CÓDE
PS10-1A	SY1340103
PS10-2A	SY1340104

Specify:

Model	
Quantity	
Number of contacts	

The equipment presented in this bulletin is to be installed in accordance with the latest published Standard of the National Fire Protection Association, Factory Mutual Research Corporation, or other similar organizations and also with the provisions of governmental codes or ordinances whenever applicable. This documentation is not contractual. AG Fire Sprinkler reserves the right to any kind of change without notice.